



539sp Profile Counter Top Packing System



STOCK Trays and Sealing Film

A range of different tray sizes up to 1.36 litre capacity can be used. Manufactured in HDPE, PP or PET recyclable plastics widely used in the food industry, the trays and compatible types of sealing film provide an exceptionally robust and completely hermetic and liquid-tight pack. If required, the pack can be re-heated in microwave or conventional ovens.

The profile cutting blades trim the lidding film neatly around the tray edge, ensuring a professional presentation of your products .

Advantages:

- *Compact and robust machine*
- *Excellent presentation - Profile cut*
- *Tamper evident, drip free and hermetic seals*
- *Fully recyclable material (HDPE, PP, PET)*
- *Stackable*
- *Tray sizes from 225ml to 1.36 litre*
- *Suitable for freezing*
- *Standard or custom die-sets*

Our program provides trays, machines, film and full support from one supplier.

TECHNICAL SPECIFICATIONS

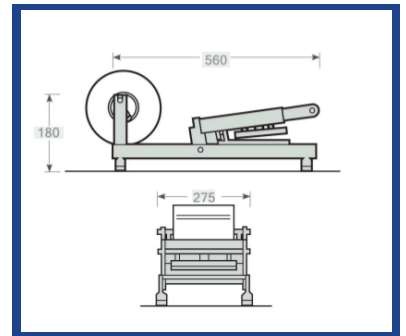

Weight: 10.5kg (ca.)

Electric Power: 600W

Voltage: 110V, 60Hz

single phase





For more information contact us at 514-426-1266 or at 1-844-426-1266.

539sp Profile



Sizes and Specifications



Large Sizes: 227 x 177mm

	Preview	Reference	Depth (mm)	Volume (cc)	Material
Single Compartment		2016	35	1050	C-PET
		5016	35	1050	PP
Single Compartment		2018	50	1360	C-PET
		5018	50	1360	PP
Two Compartments		2116	35	555/345	C-PET
		5116	35	555/345	PP

Small Sizes: 188 x 137mm

	Preview	Reference	Depth (mm)	Volume (cc)	Material
Single Compartment		2092	35	600	C-PET
		5092	35	600	PP
Single Compartment		2166	37	550	C-PET
Two Compartments		2295	35	295/225	C-PET

Sealing Films

Available in: Peelable
Non-Peelable
Universal Compatibility
Various widths in stock

For more information, contact **STOCK** at 514-426-1266 or at 1-844-426-1266.